

Transient Voltage Suppressors

SMCJ Series

Transient Voltage Suppressors - SMCJ Series

Features

- For surface mounted applications
- Low-profile package
- Optimized for LAN protection applications
- Ideal for ESD protection of data lines in accordance with IEC 1000-4-2 (IEC801-2)
- Ideal for EFT protection of data lines in accordance with IEC 1000-4-4 (IEC801-4)
- Low incremental surge resistance
- IEC 1000-4-2 (ESD) 15 kV (air) 8 kV (contact)
- IEC 1000-4-4 (EFT) 40 A ($t_p = 5/ 50 \text{ ns}$)
- IEC 1000-4-5 (Lightning) 24 A ($t_p = 8/ 20 \mu\text{s}$)
- Low incremental surge resistance, excellent clamping capability
- 1500W peak pulse power capability with a 10/1000 μ swaveform, repetition rate (duty cycle): 0.01%•
- Very fast response time
- High temperature soldering guaranteed: 260°C/ 10 seconds at terminals

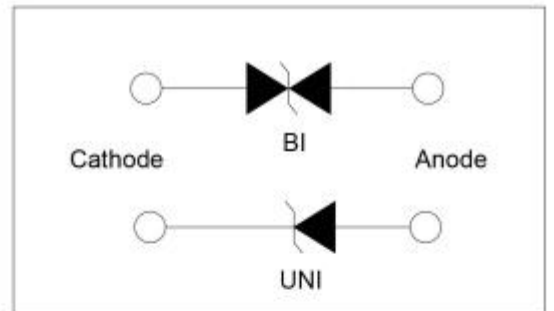

Applications

The SMCJ series is designed specifically to protect sensitive electronic equipment from voltage transients induced by lightning and other transient voltage events.

Mechanical Characteristics

Rating	Symbol	Value	Units
Peak Pulse Power Dissipation at TA=25°C by 10x1000 μs waveform	P_{PPM}	1500	Watts
Power Dissipation on infinite heat sink at TA=50°C	P_D	6.5	Watts
Peak Forward Surge Current, 8.3ms Single Half Sine Wave	I_{FSM}	200	Amps
Maximum Instantaneous Forward Voltage at 25A for Unidirectional only	V_F	3.5V/5.0	V
Operating junction and Storage Temperature Range.	T_J, T_{STG}	-55°C to 150°C	°C
Typical Thermal Resistance Junction to Lead	R_{wL}	15	°C/W
Typical Thermal Resistance Junction to Ambient	R_{uJA}	75	°C/W

Notes:

1. Non-repetitive current pulse, per Fig. 3 and derated above TA = 25°C per Fig. 2.
2. Measured on 8.3ms single half sine wave or equivalent square wave, duty cycle=4 per minute maximum.
3. $V_F < 3.5V$ for devices of VBR < 200V and $V_F < 5.0V$ for devices of VBR > 201V.

Electrical Characteristics

Type Number		Device Marking Code		Reverse Stand-Off Voltage	Breakdown Voltage@I _T		Test Current	Maximum Clamping Voltage@I _{pp}	Peak Pulse Current	Reverse Leakage @V _{RWM}
(UNI)	(BI)	UNI	BI	V _{RWM} (V)	V _{BR} MIN.(V)	V _{BR} MAX.(V)	I _T (mA)	V _C (V)	I _{pp} (A)	I _R (μA)
SMCJ5.0A	SMCJ5.0CA	GDE	BDE	5.0	6.40	7.25	10	9.2	163.0	800
SMCJ6.0A	SMCJ6.0CA	GDG	BDG	6.0	6.67	7.67	10	10.3	145.7	800
SMCJ6.5A	SMCJ6.5CA	GDK	BDK	6.5	7.22	8.30	10	11.2	134.0	500
SMCJ7.0A	SMCJ7.0CA	GDM	BDM	7.0	7.78	8.95	10	12.0	125.0	200
SMCJ7.5A	SMCJ7.5CA	GDP	BDP	7.5	8.33	9.58	1	12.9	116.3	100
SMCJ8.0A	SMCJ8.0CA	GDR	BDR	8.0	8.89	10.23	1	13.6	110.3	50
SMCJ8.5A	SMCJ8.5CA	GDT	BDT	8.5	9.44	10.82	1	14.4	104.2	20
SMCJ9.0A	SMCJ9.0CA	GDV	BDV	9.0	10.00	11.50	1	15.4	97.4	10
SMCJ10A	SMCJ10CA	GDX	BDX	10.0	11.10	12.80	1	17.0	88.3	5
SMCJ11A	SMCJ11CA	GDZ	BDZ	11.0	12.20	14.00	1	18.2	82.5	5
SMCJ12A	SMCJ12CA	GEE	BEE	12.0	13.30	15.30	1	19.9	75.4	5
SMCJ13A	SMCJ13CA	GEG	BEG	13.0	14.40	16.50	1	21.5	69.8	5
SMCJ14A	SMCJ14CA	GEK	BEK	14.0	15.60	17.90	1	23.2	64.7	5
SMCJ15A	SMCJ15CA	GEM	BEM	15.0	16.70	19.20	1	24.4	61.5	5
SMCJ16A	SMCJ16CA	GEP	BEP	16.0	17.80	20.50	1	26.0	57.7	5
SMCJ17A	SMCJ17CA	GER	BER	17.0	18.90	21.70	1	27.6	54.4	5
SMCJ18A	SMCJ18CA	GET	BET	18.0	20.00	23.30	1	29.2	51.4	5
SMCJ20A	SMCJ20CA	GEV	BEV	20.0	22.20	25.50	1	32.4	46.3	5
SMCJ22A	SMCJ22CA	GEX	BEX	22.0	24.40	28.00	1	35.5	42.3	5
SMCJ24A	SMCJ24CA	GEZ	BEZ	24.0	26.70	30.70	1	38.9	38.6	5
SMCJ26A	SMCJ26CA	GFE	BFE	26.0	28.90	33.20	1	42.1	35.7	5
SMCJ28A	SMCJ28CA	GFG	BFG	28.0	31.10	35.80	1	45.4	33.1	5
SMCJ30A	SMCJ30CA	GFK	BFK	30.0	33.30	38.30	1	48.4	31.0	5
SMCJ33A	SMCJ33CA	GFM	BFM	33.0	36.70	42.20	1	53.3	28.2	5
SMCJ36A	SMCJ36CA	GFP	BFP	36.0	40.00	46.00	1	58.1	25.9	5
SMCJ40A	SMCJ40CA	GFR	BFR	40.0	44.40	51.10	1	64.5	23.3	5
SMCJ43A	SMCJ43CA	GFT	BFT	43.0	47.80	54.90	1	69.4	21.7	5
SMCJ45A	SMCJ45CA	GFV	BFV	45.0	50.00	57.50	1	72.7	20.6	5
SMCJ48A	SMCJ48CA	GJT	BJT	48.0	53.30	61.30	1	77.4	19.4	5
SMCJ51A	SMCJ51CA	GJV	BJV	51.0	56.70	65.20	1	82.4	18.2	5
SMCJ54A	SMCJ54CA	GFX	BFX	54.0	60.00	69.00	1	87.1	17.3	5
SMCJ58A	SMCJ58CA	GFZ	BFZ	58.0	64.40	74.10	1	93.6	16.1	5
SMCJ60A	SMCJ60CA	GGE	BGE	60.0	66.70	76.70	1	96.8	15.5	5
SMCJ64A	SMCJ64CA	GGG	BGG	64.0	71.10	81.80	1	103.0	14.6	5
SMCJ70A	SMCJ70CA	GGK	BGK	70.0	77.80	89.50	1	113.0	13.3	5
SMCJ75A	SMCJ75CA	GGM	BGM	75.0	83.30	95.80	1	121.0	12.4	5
SMCJ78A	SMCJ78CA	GGP	BGP	78.0	86.70	99.70	1	126.0	11.9	5
SMCJ85A	SMCJ85CA	GGR	BGR	85.0	94.40	108.20	1	137.0	11.0	5
SMCJ90A	SMCJ90CA	GGT	BGT	90.0	100.00	115.50	1	146.0	10.3	5
SMCJ100A	SMCJ100CA	GGV	BGV	100.0	111.00	128.00	1	162.0	9.3	5
SMCJ110A	SMCJ110CA	GGX	BGX	110.0	122.00	140.50	1	177.0	8.5	5
SMCJ120A	SMCJ120CA	GGZ	BGZ	120.0	133.00	153.00	1	193.0	7.8	5
SMCJ130A	SMCJ130CA	GHE	BHK	130.0	144.00	165.50	1	209.0	7.2	5
SMCJ150A	SMCJ150CA	GHG	BHG	150.0	167.00	192.60	1	243.0	6.2	5
SMCJ160A	SMCJ160CA	GHK	BHK	160.0	178.00	197.00	1	259.0	5.8	5
SMCJ170A	SMCJ170CA	GHM	BHM	170.0	189.00	209.00	1	275.0	5.5	5
SMCJ180A	SMCJ180CA	GHP	BHP	180.0	198.00	222.00	1	292.0	5.1	5
SMCJ190A	SMCJ190CA	GHR	BHR	190.0	209.00	243.20	1	308.0	4.8	5
SMCJ200A	SMCJ200CA	GHX	BHX	200.0	220.00	247.00	1	324.0	4.6	5
SMCJ220A	SMCJ220CA	GJE	BJE	220.0	242.00	272.00	1	356.0	4.2	5
SMCJ250A	SMCJ250CA	GJG	BJG	250.0	279.00	309.00	1	405.0	3.7	5
SMCJ300A	SMCJ300CA	GJK	BJK	300.0	335.00	371.00	1	486.0	3.1	5

Transient Voltage Suppressors - SMCJ Series

I-V Curve Characteristics

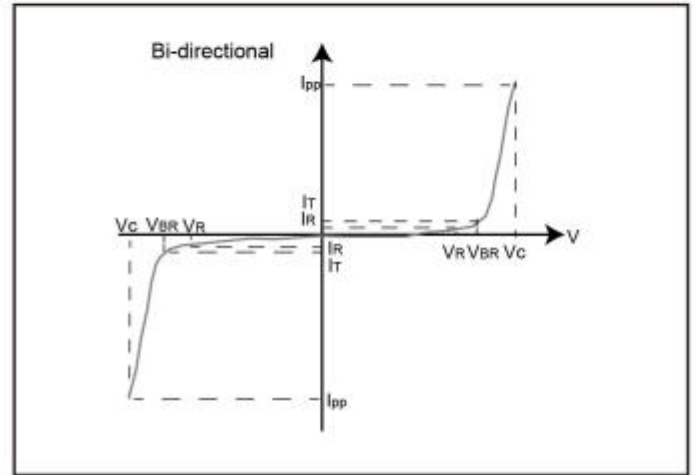
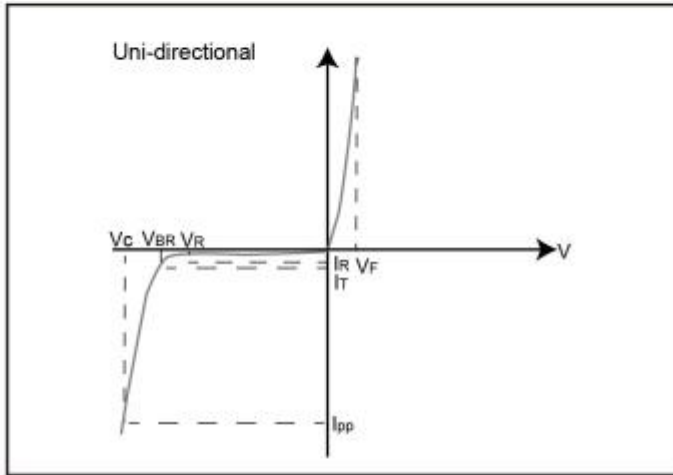

P_{PPM} Peak Pulse Power Dissipation Max power dissipation

V_R Stand-off Voltage- Maximum voltage that can be applied to the TVS without operation

V_{BR} Breakdown Voltage- Maximum voltage that flows through the TVS at a specified test current (I_T)

V_C Clamping Voltage- Peak voltage measured across the suppressor at a specified I_{ppm} (peak impulse current)

I_R Reverse Leakage Current Current measured at V_R

V_F Forward Voltage Drop for Uni-directional

Ratings and Characteristic Curves ($T_A=25^\circ\text{C}$ unless otherwise noted)

Figure 1 - TVS Transients Clamping Waveform

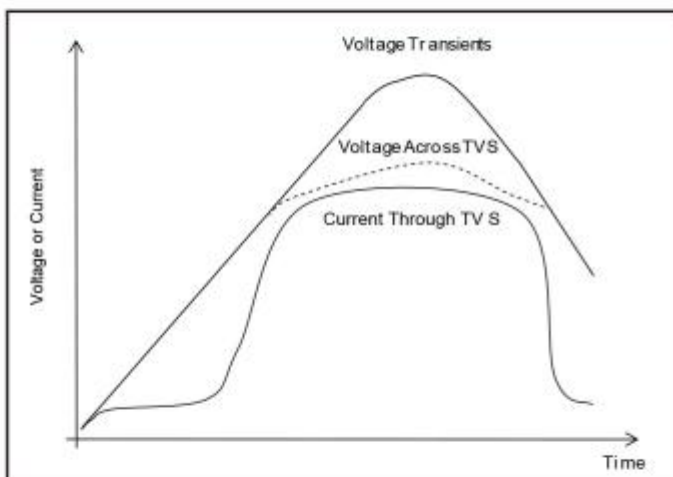
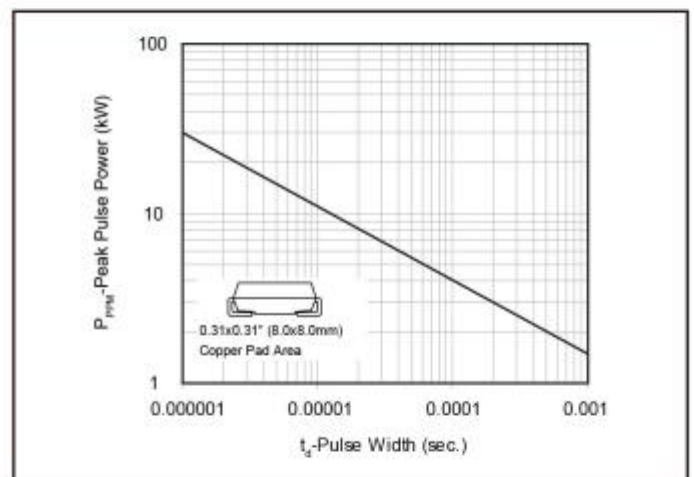

Figure 2 - Peak Pulse Power Rating



continues on next page.

Transient Voltage Suppressors - SMCJ Series

Ratings and Characteristic Curves (TA=25°C unless otherwise noted) (Continued)

Figure 3 - Pulse Derating Curve

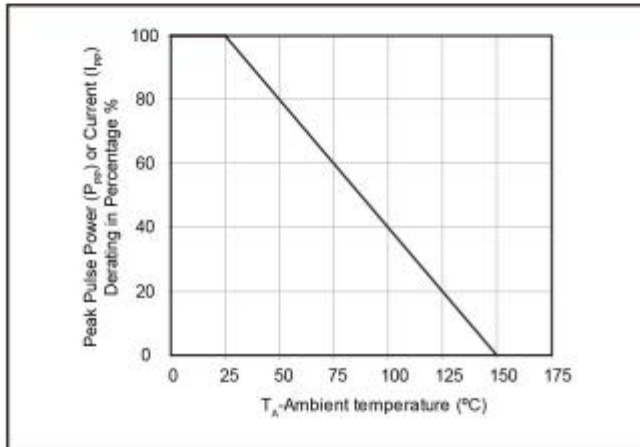

Figure 4 - Pulse Waveform

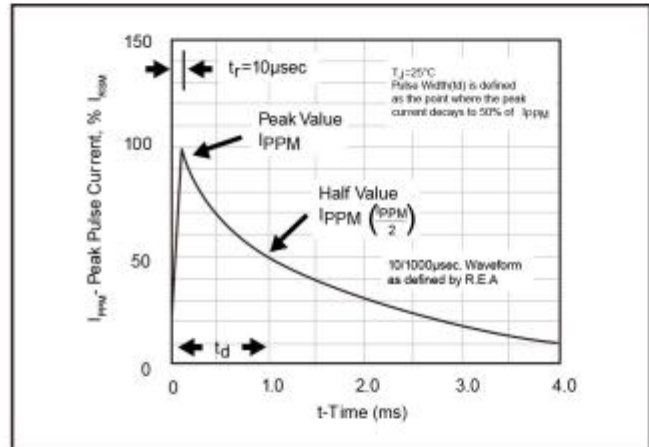

Figure 5 - Typical Junction Capacitance

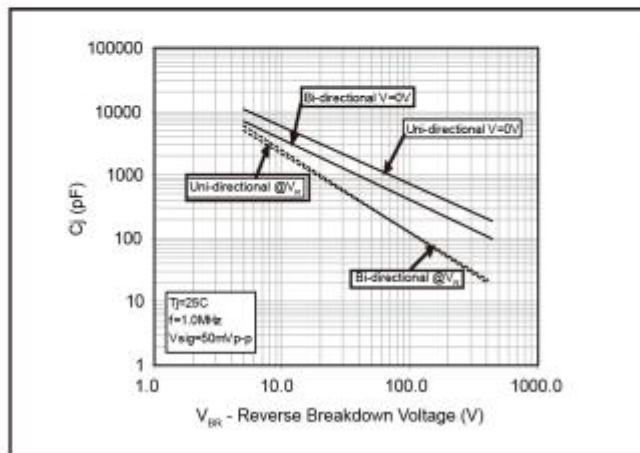

Figure 6 - Steady State Power Dissipation Derating Curve

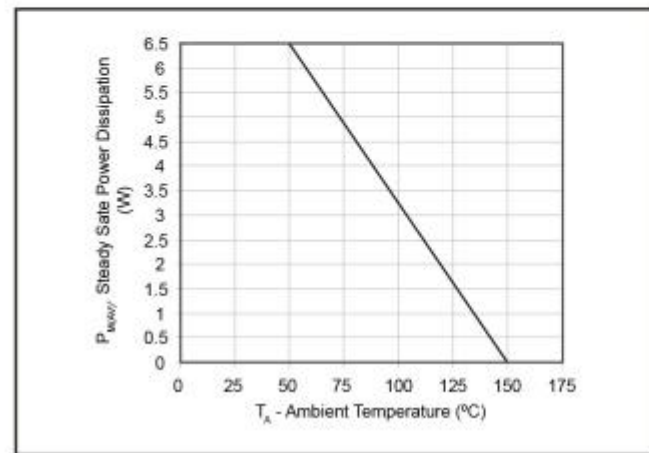
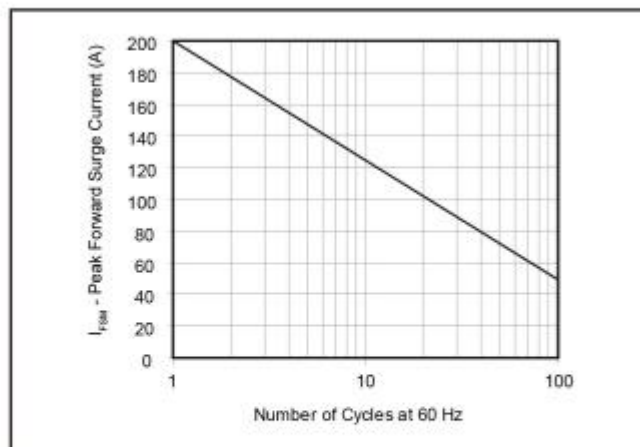

Figure 7 - Maximum Non-Repetitive Peak Forward Surge Current Uni-Directional Only



Transient Voltage Suppressors - SMCJ Series

Soldering Parameters

Feflow Condition		Lead-free assembly
Pre Heat	- Temperature Min ($T_{s(min)}$)	150°C
	- Temperature Max ($T_{s(max)}$)	200°C
	- Time (min to max) (t_s)	60-180 secs
Average ramp up rate (Liquidus Temp (T_L) to peak)		3°C/second max
$T_{S(max)}$ to T_L - Ramp-up Rate		3°C/second max
Reflow	- Temperature (T_L) (Liquidus)	217°C
	- Time (min to max) (t_s)	60-150 seconds
Peak Temperature (T_p)		260 ^{+0/-5} °C
Time within 5°C of actual peak Temperature (t_p)		20-40 seconds
Ramp-down Rate		6°C/second max
Time 25°C to peak Temperature (T_p)		8 minutes Max.
Do not exceed		280°C

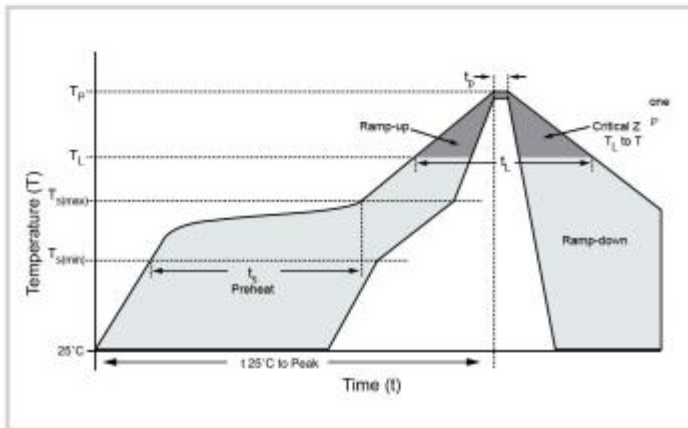

Physical Specifications

Weight	0.007 ounce, 0.21 grams
Case	JEDEC DO214AB. Molded plastic body over glass passivated junction
Polarity	Color band denotes cathode except Bidirectional.
Terminals	Matte Tin-plated leads, Solderable per JESD22-B102D

Environmental Specifications

Temperature Cycle	JESD22-A104
Pressure Cooker	JESD 22-A102
High Temp. Storage	JESD22-A103
HTRB	JESD22-A108
Thermal Shock	JESD22-A106

Transient Voltage Suppressors - SMCJ Series

Dimensions

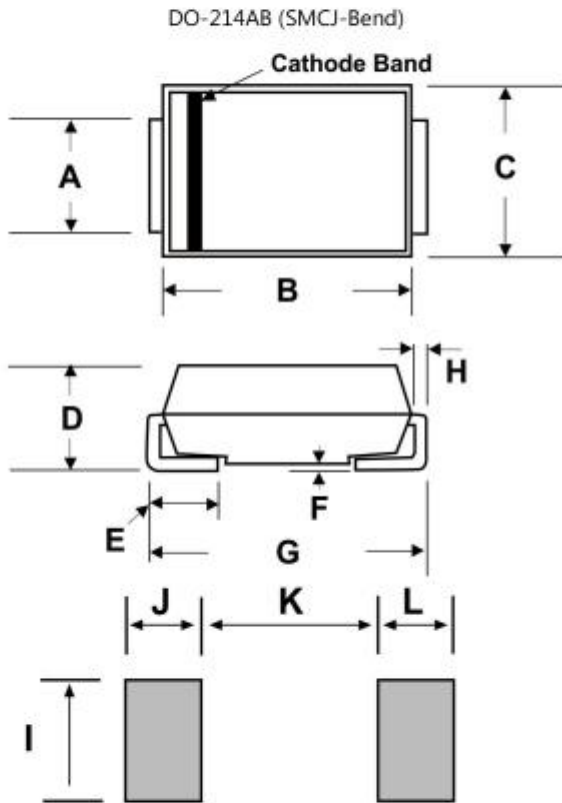

Unit:mm

DIM	Inches		Millimeters	
	Min	Max	Min	Max
A	0.114	0.126	2.900	3.200
B	0.260	0.280	6.600	7.110
C	0.220	0.245	5.590	6.220
D	0.079	0.103	2.060	2.620
E	0.030	0.060	0.760	1.520
F	-	0.008	-	0.203
G	0.305	0.320	7.750	8.130
H	0.006	0.012	0.152	0.305
I	0.129	-	3.300	-
J	0.094	-	24.00	-
K	-	0.165	-	4.200
L	0.094	-	2.400	-

Part Numbering System

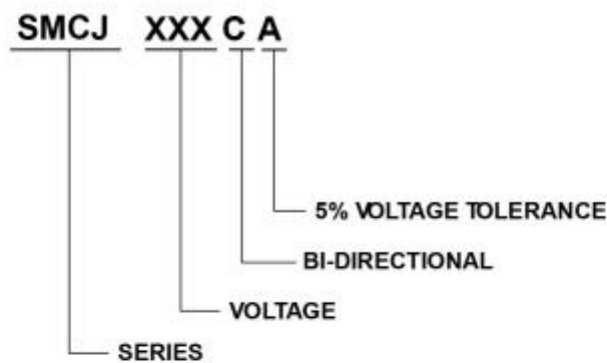

Transient Voltage Suppressors - SMCJ Series

Packaging

Part Number	Component Package	Quantity	Packaging Option	Packaging Specification
SMCJxxxXX	DO-214AB	500	Tape & Reel-16mm/13"tape	EIA STD RS-481

Tape and Reel Specification

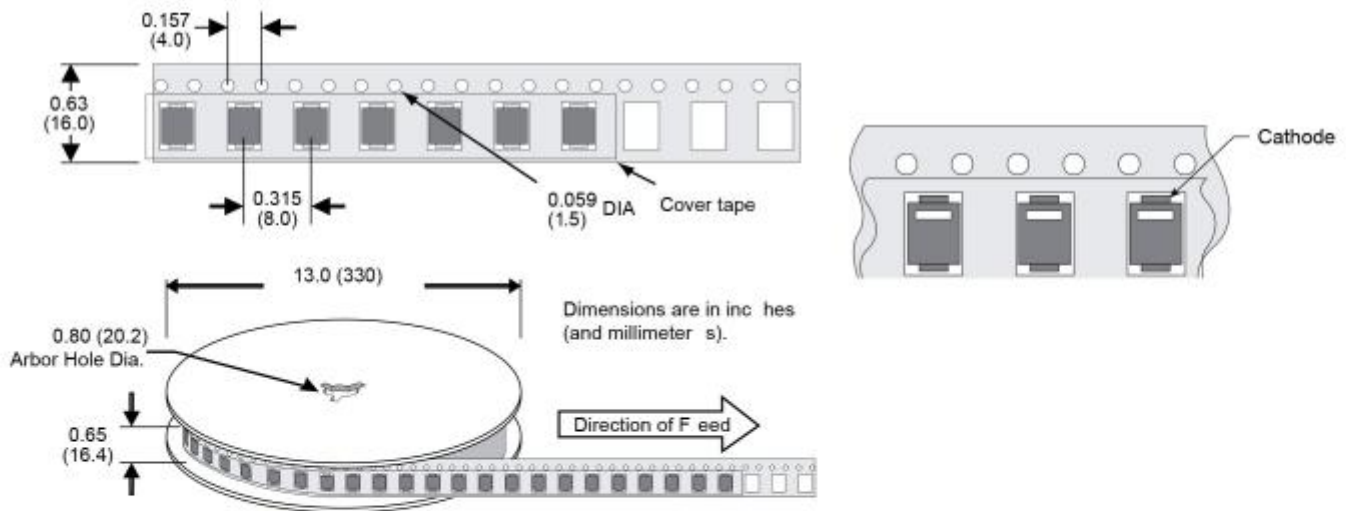

RuiLongYuan Electronics Co., Ltd.

- Reproducing and modifying information of the document is prohibited without permission from RuiLongYuan International Inc.
- RuiLongYuan International Inc. reserves the rights to make changes of the content herein the document anytime without notification. Please refer to our website for the latest document.
- RuiLongYuan International Inc. disclaims any and all liability arising out of the application or use of any product including damages incidentally and consequentially occurred.
- RuiLongYuan International Inc. does not assume any and all implied warranties, including warranties of fitness for particular purpose, non-infringement and merchantability.
- Applications shown on the herein document are examples of standard use and operation. Customers are responsible in comprehending the suitable use in particular applications. RuiLongYuan International Inc. makes no representation or warranty that such applications will be suitable for the specified use without further testing or modification.
- The products shown herein are not designed and authorized for equipments requiring high level of reliability or relating to human life and for any applications concerning life-saving or life-sustaining, such as medical instruments, transportation equipment, aerospace machinery et cetera. Customers using or selling these products for use in such applications do so at their own risk and agree to fully indemnify RuiLongYuan International Inc. for any damages resulting from such improper use or sale.

Tel: +86-769-85075532

Fax: +86-769-85383337

E-mail: danny@dgxinmu.com